



CGEM™ II

INSTRUCTION MANUAL

For Models: 91523

12010 12011 12012

12017 12018 12019

TABLE OF CONTENTS

Introduction	5
CGEM II Mount	6
Assembly	7
Computerized Hand Control	12
Object Catalog	16
Slewing to an Object.	16
CGEM II Main Menu Tree	23
Polar Aligning the Mount	25
Appendix A - CGEM II Mount Technical Specifications	29

Introduction

Congratulations on your purchase of the Celestron CGEM II telescope mount. The CGEM II German equatorial mount has been designed with the highest quality materials to ensure stability and durability. All this adds up to a telescope that gives you a lifetime of enjoyment with a minimal amount of maintenance.

Furthermore, the CGEM II mount is versatile – it will grow with you as your interest grows from astronomical observing to astroimaging.

If you are new to astronomy, you may wish to start off by using the built-in Sky Tour feature, which commands the telescopes to find the most interesting objects in the sky and automatically slews to each one. If you are an experienced amateur, you will appreciate the comprehensive database of over 40,000 objects, including customized lists of all the best deep-sky objects, bright double stars and variable stars. No matter your level of experience, CGEM II will help you and your friends explore the wonders of the universe.

Some of the features of the CGEM II include:

- High-torque motors for helping to smoothly drive heavier loads
- Permanently Programmable Periodic Error Correction (PEC) to improve your tracking performance
- A dedicated autoguider port for making corrections when astroimaging
- Large, easy to access polar alignment knobs for quick and sure movements
- Ergonomic design that disassembles into compact and portable pieces
- Database filters for creating custom object lists
- Storage for programmable user defined objects
- Many other high performance features

The CGEM II mount provides amateur astronomers with the most sophisticated and easy to use telescopes available on the market today.

Take time to read through this manual before embarking on your journey through the universe. It may take a few observing sessions to become familiar with your telescope, so you should keep this manual handy until you have fully mastered your telescope's operation. The hand control has built-in instructions to guide you through all the alignment procedures needed to have the telescope up and running in minutes. Use this manual in conjunction with the on-screen instructions provided by the hand control. The manual gives detailed information regarding each step as well as needed reference material and helpful hints guaranteed to make your observing experience as simple and pleasurable as possible.

Your telescope is designed to give you years of fun and rewarding observations. However, there are a few things to consider before using your telescope that will ensure your safety and protect your equipment.



Warning

- Never look directly at the Sun with the naked eye or with a telescope (unless you have the proper solar filter). Permanent and irreversible eye damage may result.
- Never use your telescope to project an image of the Sun onto any surface. Internal heat build-up can damage the telescope and any accessories attached to it.
- Never use an eyepiece solar filter or a Herschel wedge. Internal heat build-up inside the telescope can cause these devices to crack or break, allowing unfiltered sunlight to pass through to the eye.
- Never leave the telescope unsupervised. Make sure an adult who is familiar with the correct operating procedures is with your telescope at all times, especially when children are present.

CGEM II Mount (Shown with 11" Edge Optical Tube Assembly)



1	Optical Tube
2	CGEM II Equatorial Mount
3	Counterweight Bar
4	Counterweight
5	Control Panel
6	Latitude Adjustment Scale
7	Hand Control
8	Tripod Center Leg Brace/Accessory Tray
9	Tripod



	CONTROL PANEL
A	Auto Guider Port
B	Auxiliary Port
C	Hand Control Port
D	Power Port
E	Power Switch

Assembly

This section covers the assembly instructions for your Celestron CGEM II mount. Your mount should come with all of the following:

- Equatorial head
- Tripod
- Accessory tray
- Counterweight bar with locking nut
- Azimuth adjustment screws (x2)
- Hand control
- Hand control holder (2 pieces)
- Car battery adapter cable
- Counterweight

If you purchased the CGEM II mount by itself, you should receive one counterweight in the tripod box. If you purchased an CGEM II telescope kit, you may receive one or two additional counterweights, depending on the optical tube included in the kit. These counterweights will be packed in separate boxes. More information can be found in the section of the manual concerning the use of your optical tube.

Remove all the pieces from their respective inner boxes and place on a flat, clear work area. A large floor space is ideal. When setting up your Celestron mount, you must start with the tripod and work up from there. These instructions are laid out in the order each task must be performed.

Setting up the Tripod

The CGEM II tripod comes with an all-metal center leg brace/accessory tray to give rock solid support to the mount.

The tripod comes fully assembled with a metal plate, called the tripod head that holds the legs together at the top. In addition, there is a central rod that extends down from the tripod head that attaches the equatorial mount to the tripod.

To set up the tripod:

1. Stand the tripod upright and pull the tripod legs apart until each leg is fully extended. The tripod will now stand by itself.
2. To adjust the height of the legs, loosen the lever found at the bottom of each leg by rotating it counterclockwise.
3. Slide each leg out to the desired length and secure in place by rotating the levers clockwise. Make sure the levers are tight so the legs do not accidentally slide inward when you add weight to the tripod.

The inner tripod legs are marked at regular intervals to make it easier for you to level your tripod. Simply count the marks exposed on each leg to determine if the legs are all extended to the same length.

Attaching the Azimuth Adjustment Knobs

To ensure safe shipment of your CGEM II mount, the azimuth adjustment knobs have been removed from the mount and will need to be attached.

Before securing the mount to the tripod:

1. Locate the Azimuth Adjustment Knobs from the box containing the CGEM II equatorial head.
2. Thread one knob into each of the holes located on either side of the mount.
3. Only thread the knobs about half way in, leaving enough space for the tripod alignment peg which will need to fit between the two screw tips.

Attaching the Equatorial Mount

The CGEM II equatorial mount allows you to tilt the telescope's axis of rotation so that you can track the stars as they move across the sky. On one side of the tripod head is a metal alignment peg for aligning the mount. This side of the tripod will face north when setting up for an astronomical observing session. To attach the equatorial head:

1. Locate the azimuth adjustment screws on the equatorial mount.
2. Retract the azimuth adjustment screws so they no longer extend into the azimuth housing on the mount. **Do NOT remove the screws since they are needed later for polar alignment.**
3. Hold the equatorial mount over the tripod head so the azimuth housing is above the metal peg.
4. Place the equatorial mount on the tripod head so that the two are flush.
5. Push the mounting knob located on the central rod on the underside of the tripod head upward and turn it clockwise to hold the equatorial mount firmly in place.



Your CGEM II tripod comes with the alignment peg installed so the polar axis and counterweight bar extends between two tripod legs. If you wish, you can reposition the alignment peg so the counterweight bar extends directly over a tripod leg. This is a matter of personal preference and does not affect the stability of the mount. Observers at lower latitudes will prefer to leave the alignment peg between two legs to avoid the counterweight from making contact with the tripod leg when the counterweight is in the lowest part of its swing. To change the position of the alignment peg:

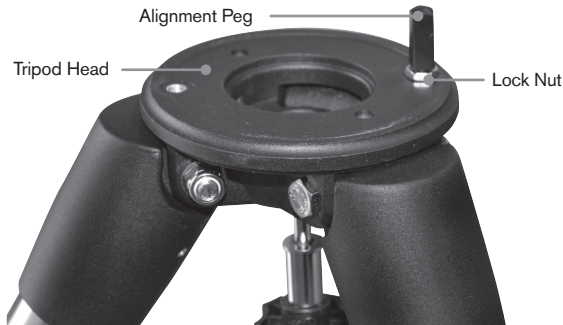

1. Use a wrench to hold the alignment peg in place while using another wrench to loosen the locking nut underneath the alignment peg.
2. Once the nut is loose, you can unthread the alignment peg and move it to the threaded hole on the opposite side of the tripod head.
3. Thread the peg in until it stops, and back it off until the flat sides of the alignment peg are square to the tripod.
4. Hold the peg in this position with one wrench while using another wrench to tighten the locking nut against the tripod head.
5. Mount the equatorial head as described above.

Attaching the Accessory Tray

The CGEM II mount comes with an accessory tray that has holes specially designed for 1.25" and 2" eyepieces. The accessory tray also acts as a tripod leg tensioner to add stability to the mount. To install the tray:

1. Remove the nut and washer from the lower side of the tripod's central rod.
2. Slide the accessory tray over the central rod so that each arm of the tray is pushing against the inside of the tripod legs.
3. Thread the accessory tray knob onto the central rod and tighten.



Installing the Counterweight Bar

To properly balance the telescope, the mount comes with a counterweight bar and at least one counterweight (depending on model). To install the counterweight bar:

1. Locate the counterweight bar and locking nut from the box containing the equatorial head. The locking nut should already be threaded onto the end of the counterweight bar.
2. Locate the opening in the equatorial mount on the declination axis and thread the counterweight bar into the opening until it is tight.
3. Tighten the counterweight bar lock nut fully.



Once the bar is securely in place, you are ready to attach the counterweight.

Observing Tip: Since the fully assembled telescope can be quite heavy, position the mount so that the polar axis is pointing towards north before the optical tube assembly and counterweights are attached. This will make the polar alignment procedure much easier.

Installing the Counterweight

To install the counterweight(s) that were included with your mount or telescope kit:

1. Orient the mount so the counterweight bar points toward the ground.
2. Remove the counterweight safety screw on the bottom end of the counterweight bar by turning it counterclockwise. This screw prevents the counterweight from falling off the mount in the case the counterweight locking screw comes loose.
3. Loosen the locking screw on the side of the counterweight.
4. Slide the counterweight over the counterweight bar and move it about halfway up the bar.
5. Tighten the locking screw on the side of the counterweight to hold it in place.
6. Replace the counterweight safety screw.

Attaching the Hand Control Holder

The CGEM II telescope models come with a hand control holder that attaches to a tripod leg. The hand control holder comes with a hook and loop strap which attaches it to the tripod leg. To attach the hand control holder:

1. Open the hook and loop strap and wrap the strap around the tripod leg.
2. Slip the end of the strap through the buckle and pull the strap tight. Press the strap down so the hook and loop engages, securing the hand control holder in place.

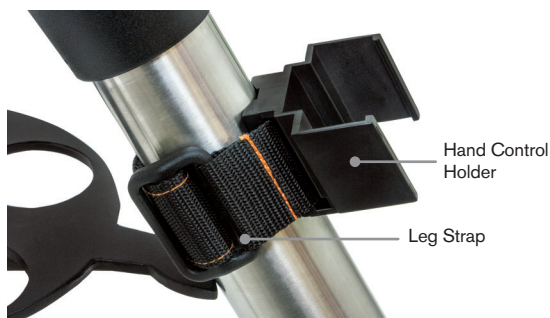

Attaching an Optical Tube to the Mount

The telescope attaches to the mount via a dovetail slide bar which is mounted along the bottom of the telescope tube. The CGEM II equatorial head has a special mounting saddle that can accept any telescope using the narrow CG-5 style dovetail bar, or the wider CGE dovetail bar. Before you attach the optical tube, make sure that the declination and right ascension clutch knobs are tight and the counterweight(s) are securely installed. This will ensure that the mount does not move suddenly while attaching the telescope. To mount the telescope tube:

1. Loosen the two mounting screws on the side of the telescope mounting platform. This allows you to slide the dovetail bar onto the mount.
2. If your telescope is equipped with one, remove the safety screws located beneath the dovetail bar.
3. Slide the dovetail bar on the telescope tube into the mounting saddle that matches the size of your dovetail bar. Slide the telescope so that the back of the dovetail bar is close to the back of the mounting platform.
4. Tighten the mounting screws on the side of the mounting platform to hold the telescope in place.

Now that the optical tube is securely in place, the visual accessories can now be attached to the telescope. This is covered in detail in the manual supplied with your telescope optical tube.



Moving the Telescope Manually

In order to properly balance your telescope, you will need to move your telescope manually at various portions of the sky to observe different objects. To make rough adjustments, loosen the R.A. and DEC clutch knobs slightly and move the telescope in the desired direction.

Both the R.A. and DEC axis have lock levers to clutch down each axis of the telescope. To loosen the clutches on the telescope, rotate the lock levers counterclockwise.

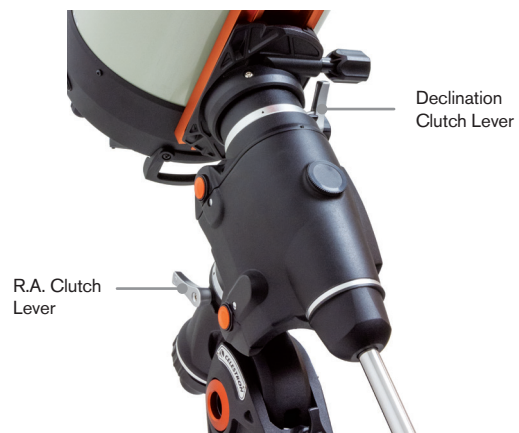

Balancing the Mount in R.A.

To eliminate undue stress on the mount, the telescope should be properly balanced around the polar axis. Proper balancing is crucial for accurate tracking. To balance the mount:

1. Verify that the telescope is securely attached to the telescope mounting platform.
2. Loosen the R.A. lock lever and position the telescope off to one side of the mount. The counterweight bar will extend horizontally on the opposite side of the mount.
3. Release the telescope – **GRADUALLY** – to see which way the telescope “rolls.”
4. Loosen the set screws on the side of the counterweight, so it can be moved the length of the counterweight bar.
5. Move the counterweight to a point where it balances the telescope (i.e., the telescope remains stationary when the R.A. clutch knobs are loose).
6. Tighten the screw on the counterweight to hold it in place.



Tip: While the above instructions describe a perfect balance arrangement, there should be a **SLIGHT** imbalance to ensure the best possible tracking. When the scope is on the west side of the mount the counterweight should be slightly imbalanced to the counterweight bar side. And when the tube is on the east side of the mount there should be a slight imbalance toward the telescope side. This is done so that the worm gear is pushing against a slight load. The amount of the imbalance is very slight. When taking astroimages, this balance process can be done for the specific area at which the telescope is pointing to further optimize tracking accuracy.

Balancing the Mount in DEC

Although the mount does not track in declination, the telescope should also be balanced in this axis to prevent any sudden motions when the DEC lock lever is loose. To balance the telescope in DEC:

1. Loosen the R.A. clutch lock lever and rotate the telescope so that it is on one side of the mount (i.e., as described in the previous section on “Balancing the Mount in R.A.”).
2. Tighten the R.A. lock lever to hold the telescope in place.

3. Loosen the DEC clutch lock lever and rotate the telescope until the tube is parallel to the ground.
4. Release the tube – **GRADUALLY** – to see which way it rotates around the declination axis. **DO NOT LET GO OF THE TELESCOPE TUBE COMPLETELY!**
5. Slightly loosen the knobs that hold the telescope to the mounting platform and slide the telescope either forward or backward until it remains stationary when the DEC clutch is loose. Do NOT let go of the telescope tube while the knob on the mounting platform is loose. It may be necessary to rotate the telescope so that the counterweight bar is pointing down before loosening the mounting platform screw.
6. Tighten the knobs on the telescope mounting platform to hold the telescope in place.

Like R.A. balance, these are general balance instructions and will reduce undue stress on the mount. When taking astroimages, this balance process should be done for the specific area at which the telescope is pointing.

Adjusting the Mount

In order for a motor drive to track accurately, the telescope's axis of rotation must be parallel to the Earth's axis of rotation, a process known as polar alignment. Polar alignment is achieved NOT by moving the telescope in R.A. or DEC but by adjusting the mount vertically, which is called altitude and horizontally, which is called azimuth. This section simply covers the correct movement of the telescope during the polar alignment process. The actual process of polar alignment, or making the telescope's axis of rotation parallel to the Earth's, is described later in this manual in the section on “Polar Alignment.”

Adjusting the Mount in Altitude

- To increase the latitude of the polar axis, tighten the rear latitude adjustment screw and loosen the front screw.
- To decrease the latitude of the polar axis, tighten the front latitude adjustment screw (located below the counterweight bar and loosen the rear screw).

The latitude adjustment on the CGEM II mount has a range from approximately 15° to 70°.

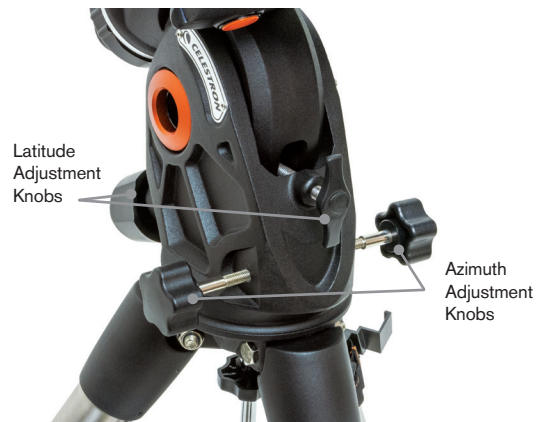

It is best to always make final adjustments in altitude by moving the mount against gravity (i.e., using the rear latitude adjustment screw to raise the mount). To do this you should loosen both latitude adjustment screws and manually push the front of the mount down as far as it will go. Tighten the rear adjustment screw to raise the mount to the desired latitude.

Adjusting the Mount in Azimuth

For rough adjustments in azimuth, simply pick up the telescope and tripod and move it. For fine adjustments in azimuth:

Turn the azimuth adjustment knobs located on either side of the azimuth housing. While standing behind the telescope, the knobs are on the front of the mount.

- Turning the right adjustment knob clockwise moves the mount toward the right.
- Turning the left adjustment knob clockwise moves the mount to the left.

Both screws push off of the alignment peg on the tripod head, which means you may have to loosen one screw while tightening the other. The screw that holds the equatorial mount to the tripod may have to be loosened slightly.

Keep in mind that adjusting the mount is done during the polar alignment process only. Once polar aligned, the mount must NOT be moved. Pointing the telescope is done by moving the mount in right ascension and declination, as described earlier in this manual.

Powering the Telescope

The CGEM II mount can be powered by the supplied car battery adapter or the optional AC to DC adapters supplied by Celestron. Use only adapters supplied by Celestron. Using any other adapter may damage the electronics and will void your manufacturer's warranty.

1. To power the telescope with the car battery adapter (or 12V AC adapter), simply plug the round post into the 12V outlet on the electronic panel and plug the other end into your car's cigarette lighter outlet or portable power supply.
2. Turn on the power to the telescope by flipping the switch, located on the electronics panel, to the "On" position.

Computerized Hand Control

The CGEM II uses the NexStar+ hand control that is designed to give you instant access to all the functions your mount has to offer. With automatic slewing to over 40,000 objects and common sense menu descriptions, even a beginner can master its variety of features in just a few observing sessions. Below is a brief description of the individual components of The NexStar+ hand controller:



1. **Liquid Crystal Display (LCD) Window:** Has a four-line, 18 character display screen that has red backlighting for comfortable viewing of telescope information and scrolling text.
2. **Align:** Instructs the hand control to begin the process of aligning your telescope.
3. **Direction Keys:** Allows complete control of the CGEM II mount in any direction. Use the direction keys to center objects in the eyepiece or manually slew telescope.
4. **Catalog Keys:** The CGEM II has a key on the hand control to allow direct access to each of the main catalogs in its 40,000+ object database. Your mount contains the following catalogs in its database:
 - Solar System – All 7 planets in our Solar System plus the Moon, Sun and Pluto.
 - Stars – Custom lists of all the brightest stars, double stars, variable stars and asterisms.
 - Deep Sky – Custom lists of all the best galaxies, nebulae and clusters as well as the complete Messier and select NGC objects.
5. **Identify:** Searches the CGEM II databases and displays the name and offset distances to the nearest matching objects.
6. **Menu:** Displays the many setup and utilities functions, such as tracking rate and user defined objects and many others.
7. **Option (Celestron Logo):** Can be used in combination with other keys to access more advanced features and functions.
8. **Enter:** Pressing **ENTER** allows you to select any of the CGEM II functions, accept entered parameters and slew the telescope to displayed objects.
9. **Back:** Pressing **BACK** will take you out of the current menu and display the previous level of the menu path. Press **BACK** repeatedly to get back to a main menu or use to erase data entered by mistake.
10. **Sky Tour:** Activates the tour mode, which seeks out all the best objects in the sky and automatically slews the CGEM II to those objects.
11. **Scroll Keys:** Used to scroll up and down within any of the menu lists. A double arrow symbol on the right side of the LCD indicates that the scroll keys can be used to view additional information.
12. **Motor Speed:** Slews the telescope faster or slower when the direction buttons are pressed.
13. **Object Info:** Displays coordinates and useful information about objects selected from the CGEM II database.
14. **Micro USB Port:** Allows you to connect your telescope to a computer, for use with software programs for point-and-click slewing capability and updating firmware via PC.

Hand Control Operation

This section describes the basic hand control procedures needed to operate all Celestron computerized telescopes. These procedures are grouped into three categories: Alignment, Setup and Utilities. The alignment section reviews the initial telescope alignment as well as finding objects in the sky. The setup section discusses changing parameters such as tracking mode and tracking rate. Finally, the last section reviews all of the utilities functions such as calibrating your mount, polar alignment and backlash compensation.

Alignment Procedures

In order for the telescope to accurately point to objects in the sky, it must first be aligned with known positions (stars) in the sky. With this information, the telescope can create a model of the sky, which it uses to locate any object with known coordinates. There are many ways to align your telescope with the sky depending on what information the user is able to provide:

- **Two Star Align** uses the entered time/location information and allows the user to select which two alignment stars the telescope will automatically slew to.
- **One Star Align** uses the same time/location information but only uses one star for alignment.
- **Solar System Align** will display a list of visible daytime objects (planets and the Moon) available to align the telescope.
- **Quick-Align** will ask you to input all the same information as you would for the Two Star Align procedure. However, instead of slewing to the alignment stars for centering and alignment, the telescope bypasses this step and simply models the sky based on the information given.
- **Last Alignment** restores your last saved star alignment and switch position. Last Alignment also serves as a good safeguard in case the telescope should lose power.

Startup Procedure

Before any of the described alignments are performed, the CGEM II mount needs to be positioned so that the index marks are aligned on both the right ascension and declination axes. Once the index position has been set, the hand control will display the last entered date and time information stored in the hand control.

1. Press **ENTER** to begin the alignment process.
2. The hand control will prompt the user to set the mount to its index position. Move the telescope mount, either manually or with the hand control, so the index marked in both R.A. and Dec are aligned. Press **ENTER** to continue.
 - The hand control will then display the last entered local time, time zone and date.
 - Use the Up/Down keys (11) to view the current parameters.

- Press ENTER to accept the current parameters.
- Press BACK to enter current date, time and location information into the hand control.

3. The following information will be displayed:

- **Location** – The hand control will display a list of cities to choose from. Choose the city from the database that is closest to your current observing site. The city you choose will be remembered in the hand control's memory so that it will be automatically displayed the next time an alignment is done. Alternatively, if you know the exact longitude and latitude of your observing site, it can be entered directly into the hand control and remembered for future use as well. To choose a location city:

- Use the Up and Down scroll keys to choose between City Database and Custom Site. City Database will allow you to select the closest city to your observing site from a list of either international or U.S. location. Custom Site allows you to enter the exact longitude and latitude of your observing site. Select City Database and press ENTER.
- The hand control will allow you to choose from either U.S. or international locations. For a listing of U.S. locations by state and then by city, press ENTER while United States is displayed. For international locations, use the Up or Down scroll key to select International and press ENTER.
- Use the Up and Down Scroll buttons to choose your current state (or country if an International location was selected) from the alphabetical listing and press ENTER.
- Use the Up and Down Scroll buttons to choose the closest city to your location from the displayed list and press ENTER.

- **Time** – Enter the current local time for your area. You can enter either the local time (i.e., 08:00), or you can enter military time (i.e., 20:00).

- Select PM or AM. If military time was entered, the hand control will bypass this step.
- Choose between Standard time or Daylight Savings time. Use the Up and Down scroll buttons (11) to toggle between options.
- Select the time zone that you are observing from. Again, use the Up and Down buttons (11) to scroll through the choices. Refer to Time Zone map in Appendix for more information.

- **Date** – Enter the month, day and year of your observing session.

Note: Updating Your Location – Since you may not need to update your observing location as often as the date and time, it is not displayed each time you update the date and time. To update your city, press BACK at any time when updating your date and time. Continue to press BACK to change the state, country or to add longitude/latitude coordinates.

Note: If incorrect information is entered into the hand control, the BACK button acts like a back space button allowing the user to re-enter the correct data.

Select one of the alignment methods as described below.

Two Star Align

Two-Star Align allows the user to select two stars on which to align the telescope. To align your telescope using the Two-Star Align method:

1. Select Two-Star Align from the alignment choices given. Based on the date and time information entered, the hand control will automatically select and display a bright star that is above the horizon.
 - Press ENTER to select this star as your first alignment star.
 - If for some reason the chosen star is not visible (perhaps behind a tree or building), press BACK to have the hand control automatically select the next brightest star.
 - Or you can use the Up/Down keys to browse the entire Named Star list and select any one of over two hundred alignment stars.
2. Once the telescope is finished slewing to your first alignment star, the display will ask you to use the arrow buttons to align the selected star with the cross hairs in the center of the finderscope. When centered in the finder, press ENTER.

The display will then instruct you to center the star in the field of view of the eyepiece. When the star is entered, press ALIGN to accept this star as your first alignment star.

Important: When moving the telescope, remember to always finish slewing using the UP and RIGHT direction buttons on the hand control to eliminate any mechanical backlash in the gears.

3. After the first alignment star has been entered, the hand control will automatically select a second alignment star and have you repeat this procedure for that star.

When the telescope has been aligned on both stars, the display will ask you if you wish to add additional calibration stars. Calibration stars are used to improve the pointing accuracy of your telescope by compensating for subtle opto-mechanical misalignments between the telescope optics and the mount. Therefore, it is usually a good idea to add at least one additional calibration star to improve the mount's all-sky pointing accuracy.

4. Press ENTER to select a calibration star. Select a star the same way you did with the first two alignment stars and press ENTER. You will notice that all the calibration stars displayed are located on the opposite side of the side of the sky (Meridian) as the original alignment stars. This is essential for an accurate calibration of the mount.

Finally, you can choose to continue to add additional calibration stars or Press BACK to complete the alignment.

Note: East/West Filtering – In order to ensure the best possible full-sky pointing accuracy, your computerized mount automatically filters and chooses its initial alignment stars so that the first two alignment stars are located on one side of the Meridian and any calibration stars are on the opposite side of the Meridian, as indicated by the “W” or “E” displayed in the upper-right corner of the LCD. East/West filtering can be changed simply by pressing the MENU button at any time during the alignment process.

Tips for adding calibration stars:

- Although for casual observing it is not necessary to add calibration stars, it is recommended that you add as many as three calibration stars for optimal point accuracy.
- Choosing calibration stars that are near the celestial equator offer the better results than stars near the celestial poles.
- Although it is not necessary to use calibration stars if the telescope mount has not been moved since its original alignment/calibration, it may be necessary to recalibrate the telescope if the optical tube has been removed for any reason.

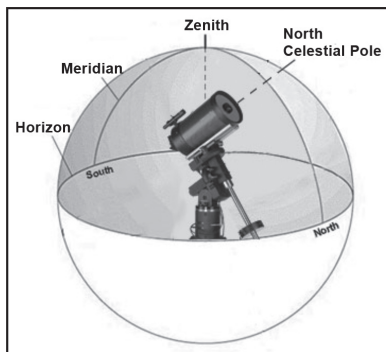

Note: Meridian – The Meridian is an imaginary line in the sky that starts at the North celestial pole and ends at the South celestial pole and passes through the zenith. If you are facing south, the meridian starts from your Southern horizon and passes directly overhead to the North celestial pole.

For safety purposes, the Sun will not be displayed in any of the hand control’s customer object lists unless it is enabled from the Utilities Menu. To allow the Sun to be displayed on the hand control, do the following:

1. Press the BACK button until the display reads “CGEM II Ready”
2. Press the MENU button and use the Up and Down keys to select the Utilities menu. Press ENTER.

3. Use the UP and Down keys to select Sun Menu and press ENTER.
4. Press ENTER again to allow the Sun to appear on the hand control display.

The Sun can be removed from the display by using the same procedure as above.

Tip: To improve the telescope pointing accuracy, you can use the Re-Align feature as described below.

Quick-Align

Quick-Align uses all the date and time information entered at startup to align the telescope. However, instead of slewing to the alignment stars for centering and alignment, the telescope bypasses this step and simply models the sky based on the information given. This will allow you to roughly slew to the coordinates of bright objects like the Moon and planets and provides the telescope with information needed to track objects in any part of the sky (depending on accuracy of polar alignment). Quick-Align is not meant to be used to accurately locate small or faint deep-sky objects or to track objects accurately for astrophotography.

To use Quick-Align, simply select Quick Align from the alignment options and press ENTER. The telescope will automatically use the entered date/time parameters to align itself with the sky and display Alignment Successful.

Note: Once a Quick-Align has been done, you can use the Re-alignment feature (see below) to improve your telescope’s pointing accuracy.

Last Alignment

The Last Alignment method will automatically recall the last stored index positions to continue using the alignment that was saved when the telescope was last powered down. This is a useful feature should your telescope accidentally lose power or be powered down.

Note: Just like with Quick-Align, you can use the Re-alignment feature (see below) to improve your telescope’s pointing accuracy after using the Last Alignment method. To maintain a more accurate alignment over a series of observing sessions, use the Hibernate feature described later in this chapter.

Re-Alignment

The mount has a re-alignment feature which allows you to replace any of the original alignment stars with a new star or celestial object. This can be useful in several situations:

- If you are observing over a period of a few hours, you may notice that your original two alignment stars have drifted towards the west considerably. (Remember that stars are moving at a rate of 15° every hour). Aligning on a new star that is in the eastern part of the sky will improve your pointing accuracy, especially on objects in that part of the sky.

- If you have aligned your telescope using the Quick-Align method, you can use Re-Align to align on actual objects in the sky. This will improve the pointing accuracy of your telescope without having to re-enter additional information.
- If you have used the computer-assisted polar alignment method and have manually moved the mount, it may be necessary to re-align the mount for improved pointing accuracy.

To replace an existing alignment star with a new alignment star:

1. Select the desired star (or object) from the database and slew to it.
2. Carefully center the object in the eyepiece.
3. Once centered, press the **BACK** button until you are at the main menu.
4. With CGEM II Ready displayed, press the **ALIGN** key on the hand control to select Alignment Stars from the list of options.
5. The display will then ask you which alignment star you want to replace. Use the **UP** and **Down** scroll keys to select the alignment star to be replaced. It is usually best to replace the star closest to the new object. This will space out your alignment stars across the sky.
6. Press **ALIGN** to make the change.

Object Catalog

Selecting an Object

Once the telescope is properly aligned, you can choose an object from any of the catalogs in the NexStar+ hand control's database. The hand control has a key designated for each category of objects in its database; Solar System objects, Stars and Deep Sky objects.

- **Solar System** – The Solar System catalog will display all the planets (and Moon) in our Solar System that are currently visible in the sky. To allow the Sun to be displayed as a selectable object in the database, see the Sun Menu option in Scope Setup Menu.
- **Stars** – The Stars catalog displays custom lists of all the brightest stars, double (Binary) stars, variable stars, constellations and selected asterisms.
- **Deep Sky** – The Deep Sky catalog displays a list of all the best Galaxies, Nebulae and Clusters, as well as the complete Messier and select NGC objects. There is also an alphabetical list of all deep sky objects in order by their common name.

Use the scroll keys to scroll through the catalogs to find the object you want to view.

When scrolling through a long list of objects, holding down either the **UP** or **DOWN** key will allow you to scroll through the catalog rapidly.

Slewing to an Object

Once the desired object is displayed on the hand control screen, you have two options:

- **Press the OBJECT INFO Key.** This will give you useful information about the selected object such as magnitude, constellation and extended information about the most popular objects.
 - Use the **UP/DOWN** arrow buttons to scroll through the displayed object info.
 - Use the **BACK** button to return to the object database.
- **Press the ENTER Key.** This will automatically slew the telescope to the coordinates of the object displayed on the hand control. While the telescope is slewing to the object, the user can still access many of the hand control functions (such as displaying information about the object).

NOTE: The Messier, NGC and SAO catalogs require the user to enter a numeric designation. Once you have selected the appropriate catalog button and selected the Messier, NGC or SAO catalog, you will see a flashing cursor indicating you are in numeric entry mode. Enter the catalog number for the object you want to view. Press **ENTER** to command the telescope to slew to the object or hold the **OPTION** button (the Celestron logo) and press **OBJECT INFO** to see information about the object you selected.

Caution: Never slew the telescope when someone is looking into the eyepiece. The telescope can move at fast slew speeds and may hit an observer in the eye.

Sky Tour Button

The CGEM II mount includes a tour feature which allows you to choose from a list of interesting objects based on the date and time in which you are observing. The automatic tour will display only those objects that are within your set catalog filters limits. To activate the Tour feature, press the **SKY TOUR** key on the hand control.

1. Press the **SKY TOUR** button on the hand control.
2. Use the **SCROLL** buttons to select Best of Tonight.
3. The CGEM II mount will automatically slew in azimuth to its starting position which will help minimize the chance of wrapping the power cord during the tour.
4. The hand control will display the best objects to observe that are currently in the sky.
 - To see information and data about the displayed object, press the **OBJECT INFO** key. Press it once to display the coordinates of the object. Press it again to display the coordinates of the object. Press it again to display the text description. Press **BACK** to return to the previous screen.

- To slew to the object displayed, press **ENTER**.
- To see the next tour object, press the **DOWN** key.

Identify Button

Pressing the **IDENTIFY** button will search the mount's database catalogs and display the name and angular distances to the nearest matching objects from the telescope's current location. This feature can serve two purposes. First, it can be used to identify an unknown object in the field of view of your eyepiece. Additionally, Identify Mode can be used to find other celestial objects that are close to the objects you are currently observing.

For example, if your telescope is pointed at the brightest star in the constellation Lyra, choosing Identify will no doubt return the star Vega as the star you are observing. However, the Identify feature will also search its NGC and Solar System databases and display any planets or Deep Sky objects that are close by. In this example, the Ring Nebula (M57) would display as being approximately 6° away.

The brightness and proximity of the objects displayed can be defined by the user using the Identify Filter under Telescope Setup.

Direction Buttons

The hand control has four direction buttons in the center of the hand control which control the telescope motion in altitude (up and down) and azimuth (left and right). The telescope can be controlled at nine different speed rates.

1 = 2x	6 = .3° / sec
2 = 4x	7 = 1° / sec
3 = 8x	8 = 2° / sec
4 = 16x	9 = 4° / sec
5 = 32x	

Motor Speed Button

Pressing the **MOTOR SPEED** button (12) allows you to instantly change the speed rate of the motors from high speed slew rate to precise guiding rate or anywhere in between. Each rate corresponds to a number on the hand controller key pad. The number 9 is the fastest rate (approximately 4° per second, depending on power source) and is used for slewing between objects and locating alignment stars. The number 1 on the hand control is the slowest rate (2x sidereal) and can be used for accurate centering of objects in the eyepiece. To change the speed rate of the motors:

- Press the **MOTOR SPEED** key on the hand control. The LCD will display the current speed rate.
- Press the number on the hand control that corresponds to the desired speed.

The hand control has a "double button" feature that allows you to instantly speed up the motors without having to

choose a speed rate. To use this feature, simply press the arrow button that corresponds to the direction that you want to move the telescope. While holding that button down, press the opposite directional button. This will increase the speed to the maximum slew rate.

When using the **UP** and **DOWN** buttons on the hand control, the slower slew rates (6 and lower) move the motors in the opposite direction than the faster slew rates (7- 9). This is done so that an object will move in the appropriate direction when looking into the eyepiece (i.e., pressing the up arrow button will move the star upwards in the field of view of the eyepiece). However, if any of the slower slew rates (rate 6 and below) are used to center an object in the starpointer, you may need to press the opposite directional button to make the telescope move in the correct direction.

Help Button

In future firmware updates, this button will offer troubleshooting tips. For your convenience, it currently functions as a shortcut to the Messier Catalog.

Menu Button

The CGEM II mount contains many user-defined setup functions designed to give the user control over the telescopes many features. All of the setup and utility features can be accessed by pressing the **MENU** key and scrolling through the options below.

Tracking Menu

Tracking Mode – This allows you to change the way the telescope tracks depending on the type of mount being used to support the telescope. The telescope has three different tracking modes:

- **EQ North** – Used to track the sky when the telescope is polar aligned in the Northern Hemisphere.
- **EQ South** – Used to track the sky when the telescope is polar aligned in the Southern Hemisphere.
- **Off** – When using the telescope for terrestrial (land) observation, the tracking can be turned off so that the telescope never moves.

Tracking Rate – In addition to being able to move the telescope with the hand control buttons, your telescope will continually track a celestial object as it moves across the night sky. The tracking rate can be changed depending on what type of object is being observed:

- **Sidereal** – This rate compensates for the rotation of the Earth by moving the telescope at the same rate as the rotation of the Earth, but in the opposite direction. When the telescope is polar aligned, this can be accomplished by moving the telescope in right ascension only.
- **Lunar** – Used for tracking the Moon when observing the lunar landscape.
- **Solar** – Used for tracking the Sun when solar observing with the proper filter.

View Time-Site Menu

This menu displays the current time and longitude/latitude downloaded from the optional SkySync GPS receiver. It will also display other relevant time-site information like time zone, daylight saving and local sidereal time. Local sidereal time (LST) is useful for knowing the right ascension of celestial objects that are located on the Meridian at that time. View Time-Site will always display the last saved time and location entered while it is linking with the GPS. Once current information has been received, it will update the displayed information. If GPS is switched off or not present, the hand control will only display the last saved time and location.

The Hand Control Menu

The "Hand Control" menu allows you to customize certain features of the NexStar+ hand control. To access this menu, press the **MENU** button (#7 on the keypad) and use the scroll buttons to select "Hand Control" and press ENTER. Use the scroll buttons to select from the following options:

- **Lights Control:** Independently adjust the brightness of the number keypad and the LCD.
- **Scrolling Menu:** Adjust how fast words move across the face of the LCD.
- **Toggle Bold Font:** Change the format of the font displayed on the LCD from normal to boldface.
- **Set Contrast:** Use the scroll keys to adjust the contrast of the LCD.
- **Set Language:** Change the displayed language on the LCD.

Note: The Set Language feature may also appear the first time you use your new hand control. You may also initiate it at any time by holding down the Option button (the Celestron logo) for 10 seconds while powering up the telescope.

Scope Setup Menu

Setup Time-Site – Allows the user to customize the telescope's display by changing time and location parameters (such as time zone and daylight savings).

Anti-backlash – All mechanical gears have a certain amount of backlash or play between the gears. This play is evident by how long it takes for a star to move in the eyepiece when the hand control arrow buttons are pressed (especially when changing directions). The CGEM II anti-backlash feature allows the user to compensate for backlash by inputting a value which quickly rewinds the motors just enough to eliminate the play between gears. The amount of compensation needed depends on the slewing rate selected; the slower the slewing rate the longer it will take for the star to appear to move in the eyepiece. There are two values for each axis, positive and negative:

- Positive is the amount of compensation applied when you press the button in order to get the gears moving quickly without a long pause.

- Negative is the amount of compensation applied when you release the button, winding the motors back in the other direction to resume tracking.

Normally, both values should be the same. You will need to experiment with different values (from 0-99); a value between 20 and 50 is usually best for most visual observing, whereas a higher value may be necessary for photographic guiding.

To set the anti-backlash value, scroll down to the anti-backlash option and press ENTER. While viewing an object in the eyepiece, observe the responsiveness of each of the four arrow buttons. Note which directions you see a pause in the star movement after the button has been pressed. Working one axis at a time, adjust the backlash settings high enough to cause immediate movement without resulting in a pronounced jump when pressing or releasing the button. Now, enter the same values for both positive and negative directions. If you notice a jump when releasing the button but setting the values lower results in a pause when pressing the button, use the higher value for positive, but use the lower value for negative. The telescope will remember these values and use them each time it is turned on until they are changed.

Filter Limits – When an alignment is complete, the telescope automatically knows which celestial objects are above the horizon. As a result, when scrolling through the database lists (or selecting the Tour function), the hand control will display only those objects that are known to be above the horizon when you are observing. You can customize the object database by selecting altitude limits that are appropriate for your location and situation. For example, if you are observing from a mountainous location where the horizon is partially obscured, you can set your minimum altitude limit to read +20°. This will make sure that the hand control only displays objects that are higher in altitude than 20°.

Tip: If you want to explore the entire object database, set the maximum altitude limit to 90° and the minimum limit to -90°. This will display every object in the database lists regardless of whether it is visible in the sky from your location.

Direction Buttons – The direction a star appears to move in the eyepiece changes depending on which side of the Meridian the telescope tube is on. This can create confusion especially when guiding on a star during an astroimaging session. To compensate for this, the direction of the drive control keys can be changed. To reverse the button logic of the hand control, press the MENU button and select Direction Buttons from the Utilities menu. Use the Up/Down arrow keys (11) to select either the azimuth (right ascension) or altitude (declination) button direction and press ENTER. Select either positive or negative for both axes and press ENTER to save. Setting the azimuth button direction to positive will move the telescope in the same direction that the telescope tracks (i.e., towards the west). Setting the altitude buttons to positive will move the telescope counter-clockwise along the DECLINATION axis.

GoTo Approach – Lets the user define the direction that the telescope will approach when slewing to an object. This allows the user the ability to minimize the effects of backlash when slewing from object to object. Just like with Direction Buttons, setting GoTo Approach to positive will make the telescope approach an object from the same direction as tracking (west) for azimuth and counterclockwise in declination. Declination GoTo approach will only apply while the telescope tube is on one side of the Meridian. Once the tube passes over to the other side of the Meridian, the GoTo approach will need to be reversed.

To change the GoTo approach direction, simply choose GoTo Approach from the Scope Setup menu, select either Altitude or Azimuth approach, choose positive or negative and press ENTER.

Hint: In order to minimize the affect of gear backlash on pointing accuracy, the settings for Button Direction should ideally match the settings for GoTo Approach. By default, using the up and right direction buttons to center alignment stars will automatically eliminate much of the backlash in the gears. If you change the GoTo approach of your telescope, it is not necessary to change the Button Direction as well. Simply take notice of the direction the telescope moves when completing its final GoTo approach. If the telescope approaches its alignment star from the west (negative azimuth) and clockwise (negative altitude) then make sure that the buttons used to center the alignment stars also move the telescope in the same directions.

Autoguide Rate – Allows the user to set an autoguide rate as a percentage of sidereal rate. This is helpful when calibrating your telescope to a CCD autoguider for long exposure astromaging.

OTA Orientation – Some users may wish to use an optional tandem bar adapter which allows you to attach two optical tubes to the mount at the same time. When most tandem bars are attached to a mount, the optical tubes are positioned at a 90° angle from the standard configuration. In order for the mount to be successfully aligned with the stars, it must know that a tandem bar is being used and in which direction the optical tube(s) are positioned (East or West) when beginning an alignment. The tandem option must be set before beginning any of the initial star alignments. To set this option, go to the Scope Setup menu, select the Tandem option and press ENTER. Then select from one of the following options:

- **East** – If the attached optical tubes are facing towards the east when the declination index makers are aligned, select East.
- **West** – If the attached optical tubes are facing towards the west when the declination index makers are aligned, select West.
- **Normal** – If the tandem bar is no longer being used, select “normal” to turn off this feature.

Meridian – This feature instructs the mount on how to

respond when it is slewing to objects that are accessible from both sides of the Meridian. The Meridian feature allows the telescope tube to remain on a desired side of the mount when slewing, and continue to track according to the R.A. slew limits the user has set. See R.A. Limits below. The Meridian feature allows for four choices:

- **Favor Current** – Allows the mount to favor whatever side of the mount that it is currently on when slewing to objects close to the Meridian. For example, if your R.A. slew limits are set to allow the mount to track 10° past the meridian, then the telescope will continue to stay on its current side of the Meridian when slewing to objects that are as far as 10° beyond your Meridian.
- **Favor West** – If the target object is accessible from both sides of the mount, selecting “Favor West” instructs the mount to point to the object as if it were on the west side of the meridian. The optical tube will then be positioned on the east side of the mount and pointing west.
- **Favor East** – If the target object is accessible from both sides of the mount, selecting “Favor East” instructs the mount to point to the object as if it were on the east side of the meridian. The optical tube will then be positioned on the west side of the mount and pointing east.
- **Disable** – This is the default setting, which instructs the mount to always swing around to the other side of the pier as required to view objects on the opposite side of the Meridian. However, once at the desired object, the mount will continue to track past the Meridian according to the R.A. slew limits that have been set.

Mount Settings – Once the mount settings have been calibrated (see Utilities section below) the values are stored and displayed in the hand control. It is not recommended that the calibration values be changed. However each setting can be changed if necessary to improve the performance of the telescope.

- **Cone Value** – This is the cone error value set when Utilities/Calibrate Mount/DEC Switch – Cone is carried out.
- **DEC Index** – This is the declination index error value that is stored when calibration stars are added after your initial star alignment.
- **R.A. Index** – This is the R.A. index error value set when Utilities/Calibrate Mount/R.A. Switch is carried out.

R.A. Limits – Sets the limits that the telescope can slew or track in Right Ascension (R.A.) before stopping. The slew limits are represented in degrees and by default set to 0°, being the position of the telescope when the counterweight bar is extended out horizontally. However, the slew limits can be customized depending on your needs. For example, if you are using CCD imaging equipment that has cables that are not long enough to move with the telescope as it slews across the sky, you can adjust the slew limit on the side of the mount that is restricted by the cables, and command the mount the stop slewing before it reaches this point. Or if you are taking an image of an object that has just crossed the Meridian, you can set the limit to allow the mount to continue

tracking in the same direction past the Meridian without the need to “flip” the telescope around to the opposite side of the mount (see Meridian feature above). Using the first example above, the user could slew the telescope in R.A. (azimuth) until it reaches the point that the cables are extended to their maximum. Then by displaying the telescope’s azimuth in this position (by looking at Get Axis Position under the Utilities menu) you can determine the telescope’s azimuth at its most extended position. Enter this azimuth reading for either the maximum or minimum azimuth slew limit to ensure that the telescope will not slew beyond this point. The telescope slew limits can be set to automatically stop anywhere between 40° above level to 20° below level. To set the R.A. slew limit select the following:

- **R.A. East Limit** – Enter a number between +40° to -20° to define the slew limit when the tube is on the east side of the mount.
- **R.A. West Limit** – Enter a number between +40° to -20° to define the slew limit when the tube is on the west side of the mount.
- **Disable Limits** – This disables any pre-defined values that have been entered and allows the mount to track the maximum amount pass the Meridian (i.e., -20° on both sides).

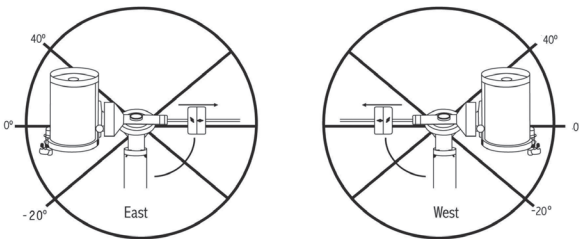

Warning: In order for the telescope to be able to slew to a star from the direction that minimizes the amount of backlash in the gears, it may be necessary for the telescope to slew beyond the specified slew limit in order to approach the star from the correct direction. This can limit your ability to slew to an object by as much as 6° from the R.A. slew limit set in the hand control. If this proves to be a problem, the direction that the telescope takes to center an object can be changed. To change the telescopes slewing direction, see GoTo Approach under the Scope Setup menu.

Custom Rate 9 – This allows you to customize the speed at which the mount slews to a target. You can set the R.A. and Dec axes individually.

Utilities Menu

Scrolling through the MENU (6) options will also provide access to several advanced utility functions within the telescope such as; Calibrate Mount, Hibernate as well as many others.

Calibrate Mount – In order to optimize the performance and pointing accuracy of the telescope, the mount has built-in calibration routines allowing it to compensate for mechanical variation inherent in every German equatorial mount. Each calibration is completely automatic and in most cases only needs to be performed once. It is highly recommended that you take a few minutes to go through the mount calibration procedures.

- **R.A. Switch** – This procedure records the offset error when the right ascension index mark is aligned at start-up. Calibrating the R.A. Index will improve the accuracy of your initial star alignments when aligning the telescope in the future.
- **GoTo Calibration** – GoTo Calibration is a useful tool when attaching heavy visual or photographic accessories to the telescope. GoTo Calibration calculates the amount of distance and time it takes for the mount to complete its final slow GoTo when slewing to an object. Changing the balance of the telescope can prolong the time it takes to complete the final slew. GoTo Calibration takes into account any slight imbalances and changes the final GoTo distance to compensate.

Home Position – The telescope’s “home” position is a user-definable position that is used to store the telescope when not in use. The home position is useful when storing the telescope in a permanent observatory facility. By default the Home position is the same as the index position used when aligning the mount.

To set the Home position for your mount, simply use the arrow buttons on the hand control to move the telescope mount to the desired position. Select the Set option and press Enter.

Select the GoTo option to slew the telescope back to the Home position at any time.

Factory Settings – Returns the hand control to its original factory settings. Parameters such as backlash compensation values, initial date and time, longitude/latitude, along with slew and filter limits will be reset. However, stored parameters such as user defined objects will remain saved even when Factory Settings is selected. The hand control will ask you to press the “0” key before returning to the factory default setting.

Version – Selecting this option will allow you to see the current version number of the hand control and motor control. The first set of numbers indicate the hand control software version. For the motor control, the hand control will display two sets of numbers; the first numbers are for azimuth and the second set are for altitude.

Get Axis Position – Displays the relative altitude and azimuth for the current position of the telescope.

GoTo Axis Position – Allows you to enter a specific relative altitude and azimuth position and slew to it.

Hibernate – Hibernate allows the telescope to be completely powered down and still retain its alignment when turned back on. This not only saves power, but is ideal for those that have their telescope permanently mounted or leave their telescope in one location for long periods of time. To place your telescope in Hibernate mode:

1. Select Hibernate from the Utility Menu.
2. Move the telescope to a desired position and press ENTER.
3. Power off the telescope. Remember to never move your telescope manually while in Hibernate mode.

Once the telescope is powered on again, the display will read Wake Up. After pressing Enter, you have the option of scrolling through the time/site information to confirm the current setting. Press ENTER to wake up the telescope.

Hint: Pressing BACK at the Wake Up screen allows you to explore many of the features of the hand control without waking the telescope up from hibernate mode. To wake up the telescope after BACK has been pressed, select Hibernate from the Utility menu and press ENTER. Do not use the direction buttons to move the telescope while in hibernate mode.

Sun Menu

For safety purposes, the Sun will not be displayed as a database object unless it is first enabled. To enable the Sun, go to the Sun Menu and press ENTER. The Sun will now be displayed in the Planets catalog and can be used as an alignment object when using the Solar System Alignment method. To remove the Sun from displaying on the hand control, once again select the Sun Menu from the Utilities Menu and press ENTER.

Set Mount Position

The Set Mount Position menu can be used to maintain your alignment in cases where you wish to disengage the clutches or similar situation. For instance, you might use this feature if you needed to rebalance the mount after having completed an alignment. To set the mount position, simply slew to a bright star in the named star list and select Set Mount Position. The hand control will sync on the star by asking you to center the star in the eyepiece and pressing the Align button. Once synced on the star, you are free to manually move the mount in both axes in order to rebalance. When you are ready to slew the telescope to your next object, just remember to manually return the tube to the same bright star and carefully center it in the eyepiece. Using this tool will invalidate the PEC index.

Turn On/Off GPS – If using your telescope with the optional SkySync GPS accessory, you will need to turn the GPS on the first time you use the accessory. If you want to use the telescope's database to find the coordinates of a celestial object for a future or past dates, you will need to turn the GPS off in order to manually enter a time other than the present.

Turn On/Off RTC – Allows you to turn off the telescope's internal real time clock. When aligning, the telescope still receives time information from the RTC. If you want to use the hand control database to find the coordinates of a celestial object for a future or past dates, you will need to turn the RTC off in order to manually enter a time other than the present.

Periodic Error Correction (PEC) – PEC is designed to improve photographic quality by reducing the amplitude of the worm gear errors and improving the tracking accuracy of the drive. This feature is for advanced astrophotography and is used when your telescope is accurately polar aligned. For more information on using PEC, refer to the section of the manual on "Astroimaging."

User Objects Menu

Your telescope can store up to 400 different user-defined objects in its memory. The objects can be daytime land objects or an interesting celestial object that you discover that is not included in the regular database. There are several ways to save an object to memory depending on what type of object it is:

GoTo Object: To go to any of the user defined-objects stored in the database, scroll down to either "GoTo Sky Obj" or "GoTo Land Obj" and enter the number of the object you wish to select and press ENTER. The telescope will automatically retrieve and display the coordinates before slewing to the object.

Save Sky Object: Your telescope stores celestial objects to its database by saving its right ascension and declination coordinates in the sky. This way the same object can be found each time the telescope is aligned. Once a desired object is centered in the eyepiece, simply scroll to the "Save Sky Obj" command and press ENTER. The display will ask you to enter a number between 1 and 200 to identify the object. Press ENTER again to save this object to the database.

Save Database (Db)

- **Object:** This feature allows you to create your own custom tour of database objects by allowing you to record the current position of the telescope and save the name of the object by selecting it from any one of the database catalogs. These objects then can be accessed by selecting GoTo Sky Object.
- **Enter R.A. - Dec:** You can also store a specific set of coordinates for an object just by entering the R.A. and declination for that object. Scroll to the "Enter RA-DEC" command and press ENTER. The display will then ask you to enter first the R.A. and then the declination of the desired object.
- **Save Land Object:** The telescope can also be used as a spotting scope on terrestrial objects. Fixed land objects can be stored by saving their altitude and azimuth relative to the location of the telescope at the time of observing. Since these objects are relative to the location of the

telescope, they are only valid for that exact location. To save land objects, once again center the desired object in the eyepiece. Scroll down to the "Save Land Obj" command and press ENTER. The display will ask you to enter a number between 1 and 200 to identify the object. Press ENTER again to save this object to the database.

To replace the contents of any of the user defined-objects, simply save a new object using one of the existing identification numbers; the telescope will replace the previous user-defined object with the current one.

Get R.A./DEC - Displays the right ascension and declination for the current position of the telescope.

Goto R.A./Dec - Allows you to input a specific R.A. and declination and slew to it.

Hint: To store a set of coordinates (R.A./Dec) permanently into the database, save it as a User-Defined Object as described above.

Identify

Identify Mode will search any of the mount's database catalogs or lists and display the name and offset distances to the nearest matching objects. This feature can serve two purposes. First, it can be used to identify an unknown object in the field of view of your eyepiece. Additionally, Identify Mode can be used to find other celestial objects that are close to the objects you are currently observing. For example, if your telescope is pointed at the brightest star in the constellation Lyra, choosing Identify and then searching the Named Star catalog will no doubt return the star Vega as the star you are observing. However, by selecting Identify and searching by the Named Object or Messier catalogs, the hand control will let you know that the Ring Nebula (M57) is approximately 6° from your current position. Searching the Double Star catalog will reveal that Epsilon Lyrae is only 1° away from Vega. To use the Identify feature:

- Press the Menu button and select the Identify option.
- Use the Up/Down scroll keys to select the catalog that you would like to search.
- Press ENTER to begin the search.

Note: Some of the databases contain thousands of objects and can therefore take several minutes to return the closest objects.

Precise GoTo

The mount has a Precise Goto function that can assist in finding extremely faint objects and centering objects closer to the center of the field of view for astroimaging. Precise GoTo automatically searches out the closest bright star to the desired object and asks the user to carefully center the star in the eyepiece. The hand control then calculates the small difference between its GoTo position and its centered position. Using this offset, the mount will then slew to the desired object with enhanced accuracy.

To use Precise GoTo:

1. Press the MENU button and use the Up/Down keys to select Precise GoTo.
 - Choose Database to select the object that you want to observe from any of the database catalogs listed or;
 - Choose R.A./DEC to enter a set of celestial coordinates that you wish to slew to.
2. Once the desired object is selected, the hand control will search out and display the closest bright star to your desired object. Press ENTER to slew to the bright alignment star.
3. Use the direction buttons to carefully center the alignment star in the eyepiece.
4. Press ENTER to slew to the desired object.

CGEM II Main Menu Tree

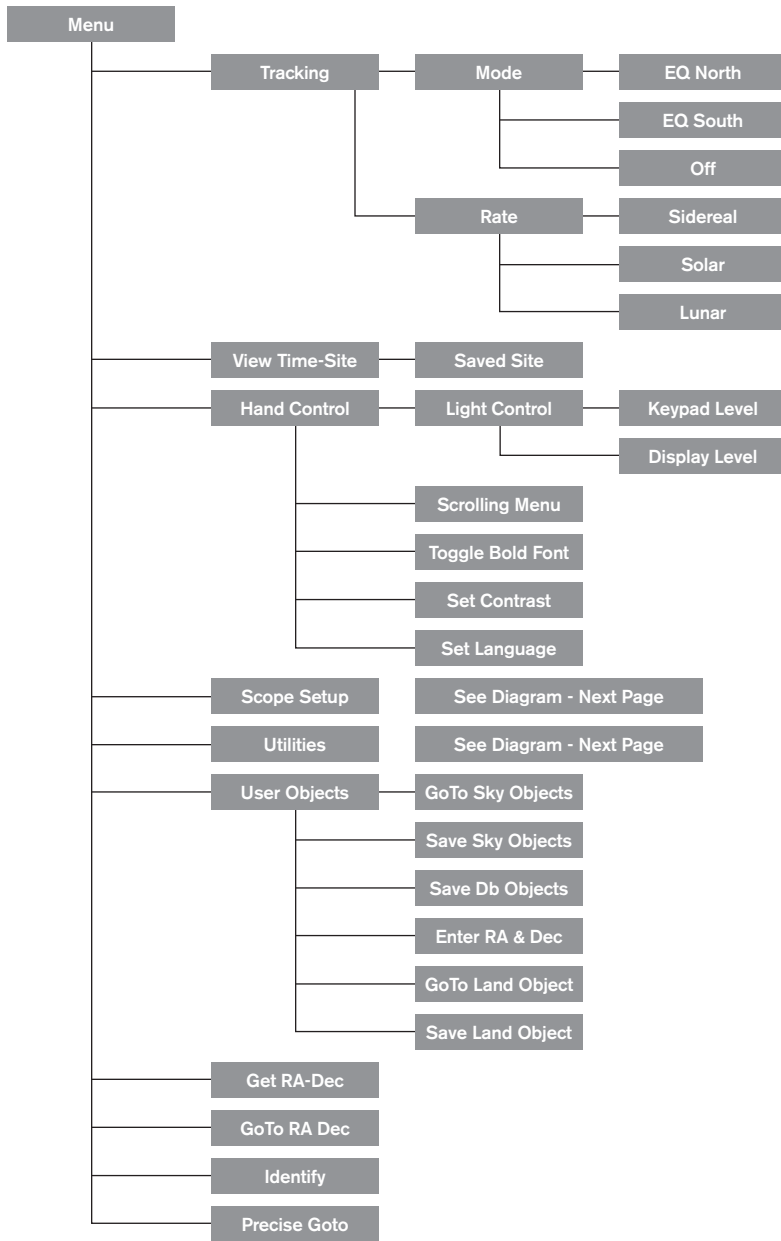

CGEM II Main Menu Tree

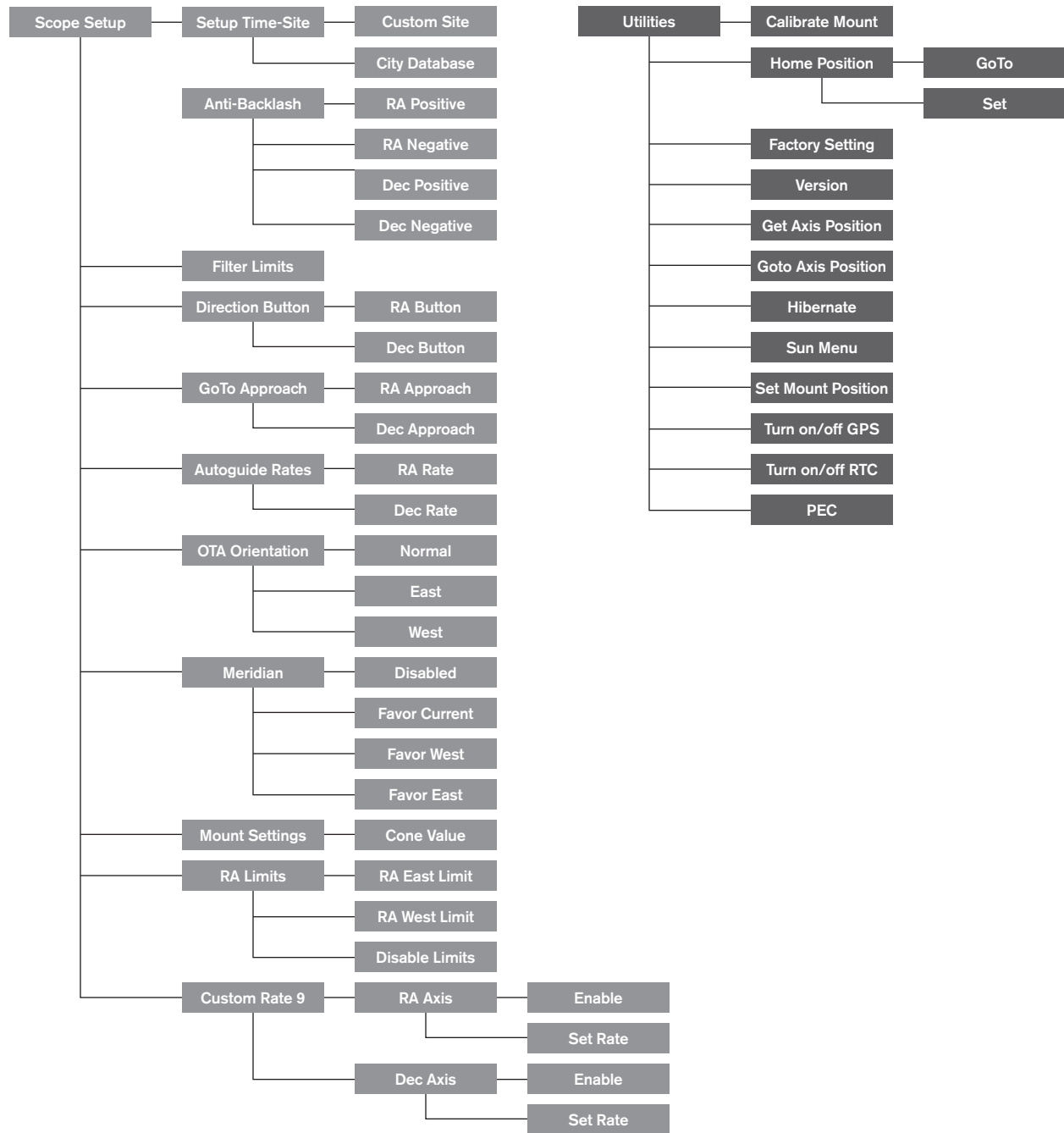

Polar Aligning the Mount

Latitude Scales

The easiest way to polar align a telescope is with a latitude scale. Unlike other methods that require you to find the celestial pole by identifying certain stars near it, this method works off of a known constant to determine how high the polar axis should be pointed. The CGEM II mount can be adjusted from 15 to 70 degrees.

The constant, mentioned above, is a relationship between your latitude and the angular distance the celestial pole is above the northern (or southern) horizon; the angular distance from the northern horizon to the north celestial pole is always equal to your latitude. To illustrate this, imagine that you are standing on the North Pole, latitude $+90^\circ$. The north celestial pole, which has a declination of $+90^\circ$, would be directly overhead (i.e., 90° above the horizon). Now, let's say that you move one degree south – your latitude is now $+89^\circ$ and the celestial pole is no longer directly overhead. It has moved one degree closer toward the northern horizon. This means the pole is now 89° above the northern horizon. If you move one degree further south, the same thing happens again. You would have to travel 70 miles north or south to change your latitude by one degree. As you can see from this example, the distance from the northern horizon to the celestial pole is always equal to your latitude.



If you are observing from Los Angeles, which has latitude of 34° , then the celestial pole is 34° above the northern horizon. All a latitude scale does then is to point the polar axis of the telescope at the right elevation above the northern (or southern) horizon. To align your telescope:

1. Make sure the polar axis of the mount is pointing due north. Use a landmark that you know faces north.
2. Level the tripod. There is a bubble level built into the mount for this purpose.
3. Adjust the mount in altitude until the latitude indicator points to your latitude. Moving the mount affects the angle the polar axis is pointing. For specific information on adjusting the equatorial mount, please see the section "Adjusting the Mount."

This method can be done in daylight, thus eliminating the need to attempt in the dark. Although this method does

NOT put you directly on the pole, it will limit the number of corrections you will make when tracking an object. It will also be accurate enough for short exposure prime focus planetary imaging (a couple of seconds) and short exposure piggyback astroimaging (a couple of minutes).

Polar Align using the Hand Control

The CGEM II mount has a polar alignment function called "All-Star" Polar Alignment that will help you polar align your telescope for increased tracking precision and for astroimaging. This feature allows you to choose any bright alignment star to assist in accurately aligning your telescope's mount with the North Celestial Pole. Before using the Polar Align feature, the scope must first be roughly pointed towards north and should be aligned with three stars in the sky. See the "Latitude Scale" section for help with finding north and adjusting the mounts latitude.

Once your telescope is aligned on two stars and at least one additional calibration star, slew the telescope to any bright star in its Named Star database list. For best results, choose a polar alignment star that is high in the sky and near the Meridian. Try to avoid stars that are close to the west/east horizon, directly overhead or too near the celestial pole. Once completed, press the Align button and use the Up/Down buttons on the hand controller to select Polar Align from the list.

Align Mount – After performing a two star alignment with one calibration star and slewing your telescope to any bright star in the telescope's database, select the "Align Mount" option. The telescope will then slew away from and then back to the same star.

1. The hand control will ask you to re-center the star in the finderscope and press ENTER.
2. The hand control will ask you to accurately center the star in your eyepiece and press ALIGN. The telescope will then "sync" on this star and slew to the position that the star should be if it were accurately polar aligned.

Note: For the most accurate alignment, it is best to use a reticle eyepiece or a high power eyepiece to precisely center the star in the field of view.

3. Use the mount's latitude and azimuth adjustments to place the star in the center of the eyepiece. Do not use the direction buttons on the hand control to position the star. Once the star is centered in the eyepiece, press ENTER; the polar axis should now be pointed towards the North Celestial Pole.

Updating your Star Alignment

After polar alignment, it is a good idea to check the pointing accuracy of the telescope to see how much it may have been affected by moving the mount. Since the polar alignment process requires you to “sync” the telescope on a bright star before you begin, it will be necessary to undo the sync before re-aligning. To undo the sync:

- Press the Align button and use the Up/Down buttons on the hand controller to select Undo Sync from the list, and press Enter. The message Complete will display on the LCD.

To re-align your telescope:

1. Slew the telescope to one of the original alignment stars or another bright star if the original alignment stars are no longer in a convenient location. Press the Align button and use the Up/Down buttons on the hand controller to select Alignment Stars from the list.
2. The hand control will ask you which of the original alignment stars you wish to replace. Use the Up/Down buttons to select the desired star and press Enter.
3. Once again, center the star in the finderscope and press Enter.
4. Center the star in the eyepiece and Press Align.
5. Repeat the process on a second alignment star.

For additional all-sky pointing accuracy, it is a good idea to align on at least one additional calibration star located on the opposite side of the Meridian. To add calibration stars:

1. Slew the telescope to a bright star on the opposite side of the Meridian from your two alignment stars.
2. Press the Align button and use the Up/Down buttons on the hand controller to select Calib. Stars from the list, and press Enter.
3. Align the star in the finderscope and then in the eyepiece as you did with the alignment stars.

Display Align – the user can now display the polar alignment error in the RA and DEC axes. These values show how close the mount is pointed at the celestial pole base on how accurately the user centered the alignment star with the hand control and with the mount adjustment. To display the alignment error:

- Press the Align button and use the Up/Down buttons on the hand controller to select Display Align from the list, and press Enter.

Pointing at Polaris

This method of Polar aligning utilizes Polaris as a guidepost to the celestial pole. Since Polaris is less than a degree from the celestial pole, you can simply point the polar axis of your telescope at Polaris. Although this is by no means perfect

alignment, it does get you within one degree and is suitable for visual observing and short exposure piggyback photography. This must be done in the dark when Polaris is visible and can be done using the hole in the polar axis or with the help of the optional polar axis finderscope.

1. Set up the telescope so the polar axis is pointing towards north.
2. Remove the polar finderscope cover and the polar axis cover from both sides of the mount. The polar finderscope cover unthreads from the rear of the mount, and the polar axis cover presses into the front of the mount
3. Loosen the DEC clutch knob and move the telescope so the tube is perpendicular to the polar axis (i.e., the tube should be pointing either due west or east).
4. Look through the hole located underneath the polar finderscope cover (or through the eyepiece if using the optional polar axis finderscope). You should be able to see the sky from the hole under the polar axis cover.
5. Adjust the mount in altitude and/or azimuth until Polaris is visible through the polar axis hole. Center Polaris as accurately as possible.

Like the Display Align method, this gets you close to the pole but not directly on it. For help in identifying and locating Polaris, read the section below.

Finding the North Celestial Pole

In each hemisphere, there is a point in the sky around which all the other stars appear to rotate. These points are called the celestial poles and are named for the hemisphere in which they reside. For example, in the northern hemisphere all stars move around the north celestial pole. When the telescope’s polar axis is pointed at the celestial pole, it is parallel to the Earth’s rotational axis.

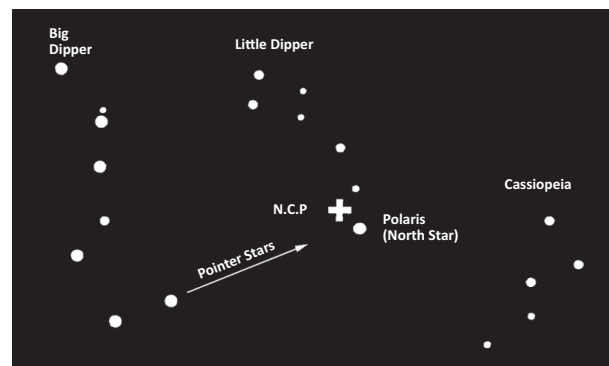

Many methods of polar alignment require that you know how to find the celestial pole by identifying stars in the area. For those in the northern hemisphere, finding the celestial pole is not too difficult. Fortunately, we have a naked eye star less than a degree away. This star, Polaris, is the end star in the handle of the Little Dipper. Since the Little Dipper (technically called Ursa Minor) is not one of the brightest constellations

in the sky, it may be difficult to locate from urban areas. If this is the case, use the two end stars in the bowl of the Big Dipper (the pointer stars). Draw an imaginary line through them toward the Little Dipper. They point to Polaris. The position of the Big Dipper changes during the year and throughout the course of the night. When the Big Dipper is low in the sky (i.e., near the horizon), it may be difficult to locate. During these times, look for Cassiopeia. Observers in the southern hemisphere are not as fortunate as those in the northern hemisphere. The stars around the south celestial pole are not nearly as bright as those around the north. The closest star that is relatively bright is Sigma Octantis. This star is just within naked eye limit (magnitude 5.5) and lies about 59 arc minutes from the pole.

Long Exposure Prime Focus Photography

This is the last form of celestial photography to be attempted after others have been mastered. It is intended primarily for deep sky objects, that is, objects outside our solar system including star clusters, nebulae, and galaxies. While it may seem that high magnification is required for these objects, just the opposite is true. Most of these objects cover large angular areas and fit nicely into the prime focus field of your telescope. The brightness of these objects, however, requires long exposure times and, as a result, are rather difficult.

There are several techniques for this type of photography, and the one chosen will determine the standard accessories needed. The best method for long exposure deep sky astrophotography is with an off-axis guider. This device allows you to photograph and guide through the telescope simultaneously. In addition, you will need a T-Ring to attach your camera to the Radial Guider.

Other equipment needs include an autoguider, which is a small camera that attaches to the radial guider and keeps your guide star centered while you are imaging with your main camera. Here is a brief summary of the technique.

1. Polar align the telescope. For more information on polar aligning, see the Polar Alignment section earlier in the manual.
2. Remove all visual accessories.
3. Thread the Radial Guider onto your telescope.
4. Thread the T-Ring onto the Radial Guider.
5. Mount your camera body onto the T-Ring the same as you would any other lens.
6. Set the shutter speed to the "B" setting.
7. Focus the telescope on a star.
8. Center your subject in the field of your camera.
9. Using your autoguider, find a suitable guide star in the telescope field. This can be the most time-consuming part of the process.
10. Open the shutter using a cable release.
11. Monitor your guide star for the duration of the exposure using the buttons on the hand controller to make the needed corrections.
12. Close the camera's shutter.

Periodic Error Correction (PEC)

Periodic Error Correction, or PEC for short, is a system that improves the tracking accuracy of the drive by reducing the number of user corrections needed to keep a guide star centered in the eyepiece. PEC is designed to improve imaging quality by reducing the amplitude of the worm errors. Using the PEC function is a three-step process. First, the CGEM II mount needs to know the current position of its worm gear, so it has a reference when playing back the recorded error. Next, you must guide using an autoguider for at least 10 minutes during which time the system records the correction you make. (It takes the worm gear 10 minutes to make one complete revolution). This "teaches" the PEC chip the characteristics of the worm. The periodic error of the worm gear drive will be stored in the PEC chip and used to correct periodic error. The last step is to play back the corrections you made during the recording phase. Keep in mind, this feature is for advanced astrophotography and still requires careful guiding since all telescope drives have some periodic error.

Using Periodic Error Correction

Once the telescope has been properly polar aligned, select PEC from the Utilities menu and select the Record option. Here's how to use the PEC function:

1. Find a bright star relatively close to the object you want to image.
2. Insert the autoguider into the eyepiece holder of your telescope. Orient the guider so that one axis of the sensor is parallel to the declination axis while the other is parallel to the R.A. axis.
3. Focus the telescope, and study the periodic movement.
4. Plug the autoguider cable into the autoguider port on the mount's electronics panel.
5. To begin recording the drive's periodic error, press the MENU button and select PEC from the Utilities menu. Use the Up/Down scroll buttons to display the Record option and press ENTER. When you are ready to record, press the ENTER button again to begin. You will have 5 seconds before the system starts to record. The first time each observing session that PEC record or play is selected, the worm gear must rotate in order to mark its starting position. If the worm gear rotation moves your guide star outside the field of view of the eyepiece, it will have to be re-centered before the recording begins.

Note: Once the worm gear is indexed, it will not need to be positioned again until the telescope is turned off. To give yourself more time to prepare for guiding, it may be necessary to restart PEC recording after the worm gear has found its index.

6. After 10 minutes, PEC will automatically stop recording.
7. Point the telescope at the object you want to image and center the guide star on the illuminated cross hairs. You are ready to play back the periodic error correction.
8. Once the drive's periodic error has been recorded, use the Playback function to begin playing back the correction for future imaging guiding. If you want to re-record the periodic error, select Record and repeat the recording processes again. The previously recorded information will be replaced with the current information. Repeat steps 7 and 8 to playback the PEC corrections for your next object.

Does the PEC function make unguided astroimaging possible? Yes and no. For solar (filtered), lunar and piggy-back (up to 200 mm), the answer is yes. However, even with PEC, autoguiding is still mandatory for long exposure, deep sky astroimaging.

Appendix A – CGEM II Mount Technical Specifications

Mount Type	German Equatorial Mount
Tripod	2" Steel tripod with graduated markings on lower section
Dovetail Mount	Directly connects to both CG-5 & CGE dovetail bars
Payload Capacity	40 pounds
Latitude Range	15 – 70 degrees
Power Requirements	12 VDC, 3.2 amps
Ports	1x Hand control port, 1x Auxiliary port, 1x Auto guider port, 1 USB 2.0 port (on hand control)
Motor Drive	Low cog DC servo motors
Slew Speeds	9 slew speeds
Tracking Rates	Sidereal, Solar and Lunar
Tracking Modes	EQ North and EQ South
Alignment Procedures	AutoAlign, 2-Star Align, Quick Align, 1-Star Align, Last Alignment, Solar System Align
Computerized Hand Control	Double line, 16 character Liquid Crystal Display; 19 fiber optic backlit LED buttons, USB 2.0 port for PC connection
Database	40,000+ objects, 100 user defined programmable objects. Enhanced information on over 200 objects.
Mount Weight	40 pounds
Tripod Weight	20 pounds
Weight of Counterweight	17 pounds
Total Weight of Mount Kit	77 pounds

CELESTRON TWO YEAR LIMITED WARRANTY

A. Celestron warrants your telescope mount to be free from defects in materials and workmanship for two years. Celestron will repair or replace such product or part thereof which, upon inspection by Celestron, is found to be defective in materials or workmanship. As a condition to the obligation of Celestron to repair or replace such product, the product must be returned to Celestron together with proof-of-purchase satisfactory to Celestron.

B. The Proper Return Authorization Number must be obtained from Celestron in advance of return. Call Celestron at (310) 328-9560 to receive the number to be displayed on the outside of your shipping container.

All returns must be accompanied by a written statement setting forth the name, address, and daytime telephone number of the owner, together with a brief description of any claimed defects. Parts or product for which replacement is made shall become the property of Celestron.

The customer shall be responsible for all costs of transportation and insurance, both to and from the factory of Celestron, and shall be required to prepay such costs.

Celestron shall use reasonable efforts to repair or replace any telescope mount covered by this warranty within thirty days of receipt. In the event repair or replacement shall require more than thirty days, Celestron shall notify the customer accordingly. Celestron reserves the right to replace any product which has been discontinued from its product line with a new product of comparable value and function.

This warranty shall be void and of no force or effect in the event a covered product has been modified in design or function, or subjected to abuse, misuse, mishandling or unauthorized repair. Further, product malfunction or deterioration due to normal wear is not covered by this warranty.

CELESTRON DISCLAIMS ANY WARRANTIES, EXPRESS OR IMPLIED, WHETHER OF MERCHANTABILITY OF FITNESS FOR A PARTICULAR USE, EXCEPT AS EXPRESSLY SET FORTH HEREIN. THE SOLE OBLIGATION OF CELESTRON UNDER THIS LIMITED WARRANTY SHALL BE TO REPAIR OR REPLACE THE COVERED PRODUCT, IN ACCORDANCE WITH THE TERMS SET FORTH HEREIN. CELESTRON EXPRESSLY DISCLAIMS ANY LOST PROFITS, GENERAL, SPECIAL, INDIRECT OR CONSEQUENTIAL DAMAGES WHICH MAY RESULT FROM BREACH OF ANY WARRANTY, OR ARISING OUT OF THE USE OR INABILITY TO USE ANY CELESTRON PRODUCT. ANY WARRANTIES WHICH ARE IMPLIED AND WHICH CANNOT BE DISCLAIMED SHALL BE LIMITED IN DURATION TO A TERM OF TWO YEARS FROM THE DATE OF ORIGINAL RETAIL PURCHASE.

Some states do not allow the exclusion or limitation of incidental or consequential damages or limitation on how long an implied warranty lasts, so the above limitations and exclusions may not apply to you.

This warranty gives you specific legal rights, and you may also have other rights which vary from state to state.

Celestron reserves the right to modify or discontinue, without prior notice to you, any model or style telescope.

If warranty problems arise, or if you need assistance in using your telescope mount contact:

Celestron
Customer Service Department
2835 Columbia Street
Torrance, CA 90503
Tel. 800.421.9649
Monday-Friday 8AM-4PM PST

NOTE: This warranty is valid to U.S.A. and Canadian customers who have purchased this product from an authorized Celestron dealer in the U.S.A. or Canada. Warranty outside the U.S.A. and Canada is valid only to customers who purchased from a Celestron's International Distributor or Authorized Celestron Dealer in the specific country. Please contact them for any warranty service.



FCC Note: This equipment has been tested and found to comply with the limits for a Class B digital device, pursuant to part 15 of the FCC Rules. These limits are designed to provide reasonable protection against harmful interference in a residential installation. This equipment generates, uses, and can radiate radio frequency energy and, if not installed and used in accordance with the instructions, may cause harmful interference to radio communications. However, there is no guarantee that interference will not occur in a particular installation. If this equipment does cause harmful interference to radio or television reception, which can be determined by turning the equipment off and on, the user is encouraged to try to correct the interference by one or more of the following measures:

- Reorient or relocate the receiving antenna.
- Increase the separation between the equipment and receiver.
- Connect the equipment into an outlet on a circuit different from that to which the receiver is connected.
- Consult the dealer or an experienced radio/TV technician for help.

Product design and specifications are subject to change without prior notification.

This product is designed and intended for use by those 14 years of age and older.

www.celestron.com
2835 Columbia Street • Torrance, CA 90503 U.S.A.
Telephone: 800.421.9649
©2016 Celestron • All rights reserved.

